

# LVP7000 Series

## LED Multi-Window

### Video wall Processor

## User Manual

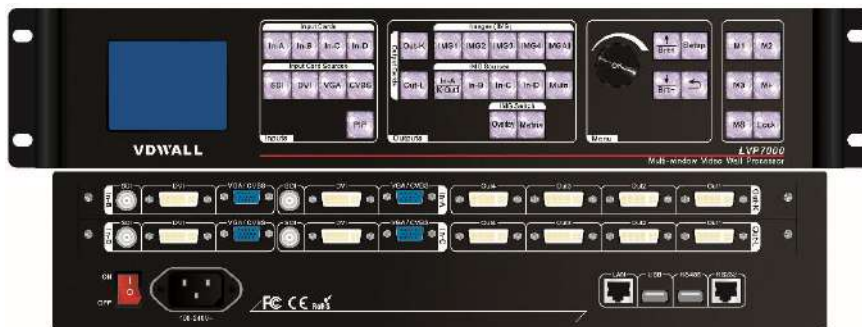

## Contents

<b>Chapter 1: Safety precautions.....</b>	<b>04</b>
<b>Chapter 2: Packing list.....</b>	<b>05</b>
<b>Chapter 3: Hardware connection.....</b>	<b>06</b>
3-1 Rear panel signal port picture.....	06
3-2 Port description .....	06
3-3 Hardware connection diagram .....	08
3-4 Technical specification .....	09
3-5 Installation dimension drawing.....	11
<b>Chapter 4: Frontal panel button description .....</b>	<b>13</b>
4-1 Frontal panel button sketch map.....	13
<b>Chapter 5: Application mode and function introduction .</b>	<b>18</b>
5-1 AppM1 (4 channels splicing or 4:4 matrix).....	19
5-2 AppM2 (4:2 seamless switching ).....	21
5-3 AppM 7(2 channels dual picture ).....	22
5-4 AppM 6(4 pictures).....	23
<b>Chapter 6: User basic operation instruction .....</b>	<b>25</b>
6-1 Input card operation .....	25
6-2 Output card operation .....	28
6-3 Another function operation .....	32
<b>Chapter 7: User setup menu instruction .....</b>	<b>35</b>
7-1 Input card setup.....	36
7-2 Output card setup.....	40
7-3 System setup .....	46
7-4 Language setup.....	48
<b>Chapter 8: System maintenance and relative operation</b>	

---

<b>instruction .....</b>	<b>50</b>
8-1 System random adjustment and verification.....	50
8-2 Data recovery.....	52
8-3 PC software import and export.....	53
 <b>Chapter 9: Mode instruction.....</b>	 <b>58</b>

## Chapter 1 Safety precautions



### **Danger !**

There is high voltage in the processor, to prevent any unexpected hazard, unless you are a maintenance personnel, please do not open the cover of the device.



### **Warning !**

- 1) This device shall not encounter water sprinkle or splash, please do not place anything containing water on this device.
- 2) To prevent fire, keep this device far from any fire source.
- 3) If this device gives out any strange noise, smoke or smell, please immediately unplug the power cord from receptacle, and contact local dealer.
- 4) Please do not plug or unplug DVI signal cable if the device is powered on.



### **Caution !**

- 1) Please thoroughly read this manual before using this device, and keep it safe.
- 2) In the event of lighting or when you are not going to use the device for a long time, please pull the power plug out of receptacle.
- 3) Nobody other than professional technicians can operate the device, unless they have been appropriately trained or under guidance of technicians.
- 4) To prevent equipment damage or electric shock, please don't fill in anything in the vent of the device.

5) Do not place the device near any water source or anywhere damp.

6) Do not place the device near any radiator or anywhere under high temperature.

7) To prevent rupture or damage of power cords, please handle and keep them properly.

8) Please immediately unplug power cord and have the device repaired, when

1. Liquid splashes to the device.
2. The device is dropped down or cabinet is damaged.
3. Obvious malpractice is found or performance degrades.







## Chapter 2 Packing list

Please unpack the product with care, and then check whether all the following items are included in the package. If anything is found missing, please contact the dealer.

### Standard accessories

The accessories supplied with this product may differ from the following pictures, but they are applicable for the regions where you live (LED sending card is optional accessory)

		
1.5m Power cable X1	1.5m DVI cable	0.5m DVI cable

	( Quantity depends on input card quantity )	( Quantity depends on output card quantity )
		
VGA transform VGA+RCA ( Quantity depends on input card quantity )	1.5m RS232-RJ45 cable X 1	1.5m USB cable X 1
		
HDMI to DVI-D adapter X 2	User manual X 1	CD of control software X 1

## Chapter 3 Hardware connection

### 3-1 Rear panel signal port picture

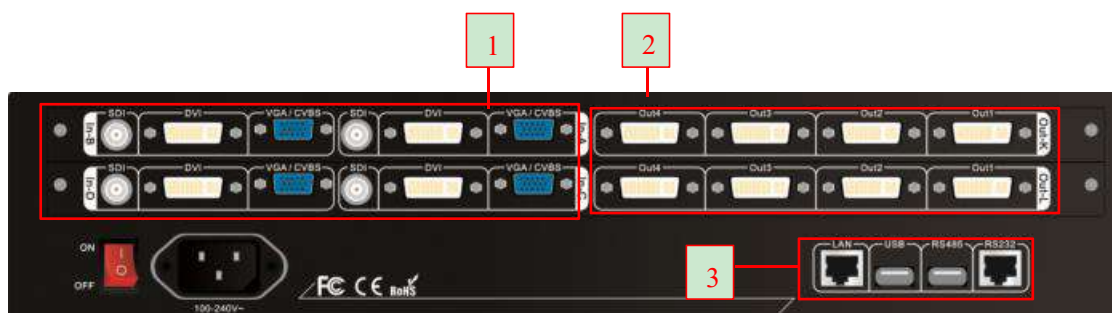

Picture 3-1 rear panel signal port picture

- ① Video input port      ② Video output port      ③ Communication port

### 3-2 Port description

## 1. Video signal input

**LVP7000** can assemble maximum 4 video input cards, the series numbers are In-A、In-B、In-C、In-D. every video input card support 4 channels of signal input, signal input port as the table below:

Ports	Description
<b>VGA/CVBS</b>	1 channel of PC analog signal input and 1 channel of PAL/ NTSC system composite video input (through VGA to VGA+RCA cable input)
<b>DVI</b>	1 channel of DVI digital signal input (compatible with HDMI1.3)
<b>SDI</b>	1 channel of SDI digital serial signal input

## 2. Video signal output

**LVP7000** can assemble maximum 2 output cards, the serial number are Out-K and Out-L. every output card can outputs 4 channels of DVI image signal, output port as the table below:

Ports	Description
<b>Out1 ~ Out4</b>	4 channels of DVI output port, used to connect LED sending card or monitor, Out1 is DVI-I port which includes VGA format signal output.

### 3. Communication port

Ports	Description
<b>LAN</b>	Local area network TCP/IP network control port
<b>USB</b>	USB communication port
<b>RS485</b>	RS485 communication port
<b>RS232</b>	Serial port communication port, RS232 electrical level



### 3-3 Hardware connection diagram



Picture 3-2 hardware connection diagram

### 3-4 Technical specification

Input signal index	
Quantity / type	4×CVBS 4×VGA ( RGBHV ) 4×DVI ( VESA/CEA-861 ) 4×SDI ( HD-SDI/3G-SDI )
Composite video system	PAL/NTSC
Composite Video Amplitude / Impedence	1V ( p_p ) / 75Ω
VGA format	PC ( VESA )      ≤1920×1200_60Hz
VGA Amplitude / Impedence	R、 G、 B = 0.7 V ( p_p ) / 75Ω
DVI format	PC ( VESA )      ≤1920×1200_60Hz
	HDMI1.3 ( CEA-861 )      ≤1080p_60Hz
SDI format	SMPTE259M-C      480i_60Hz
	SMPTE 292M      576i_50Hz
	SMPTE 274M/296M      720p、 1080i、 1080p
	SMPTE 424M/425M
Input port	CVBS : VGA socket Pin4 VGA : 15pin D_Sub (female) DVI : 24+1 DVI_D SDI : BNC/ 75Ω
Output signal index	
Quantity / type	8×DVI,2×VGA(RGBHV) ( Out1 )
VGA/DVI format	1024×768_60Hz      1920×1080p_60Hz
	1280×1024_60Hz      1920×1200_60Hz
	1440×1440_60Hz
Output port	DVI OUT : 24+5 DVI_I
Other	
Control port	RS232/USB/LAN
Input voltage	100-240VAC 50/60Hz

**LVP7000 series user manual**

Overall power consumption	≤100W
Environment temperature	0-45 °C
Environment humidity	15-85%
Product size	483( Length ) x 300( Width ) x 89( Height )mm
Packing size	540( Length ) x 400( Width ) x 180( Height )mm
Weight	G.W. : 9Kg, N.W. : 5Kg

### 3-5 Installation dimension

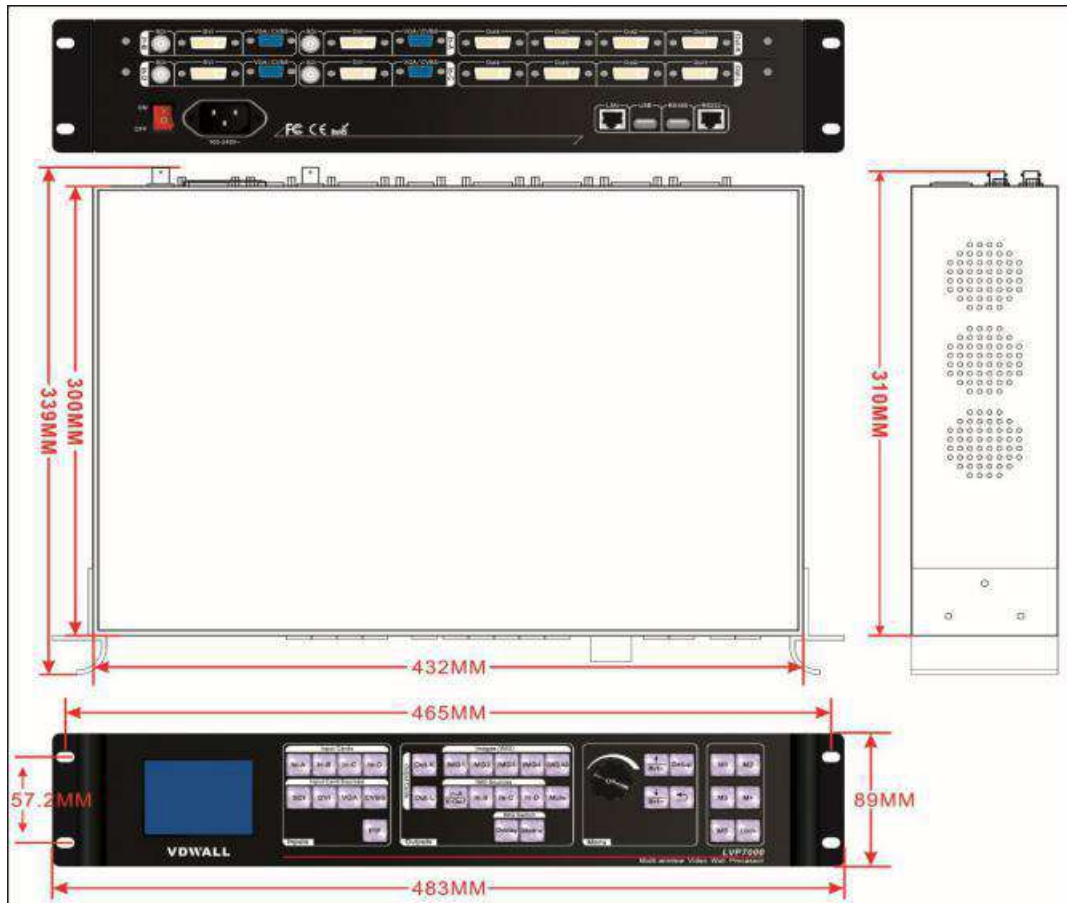

Picture 3-5a installation dimension drawing

## RS232 connection wires, wires order

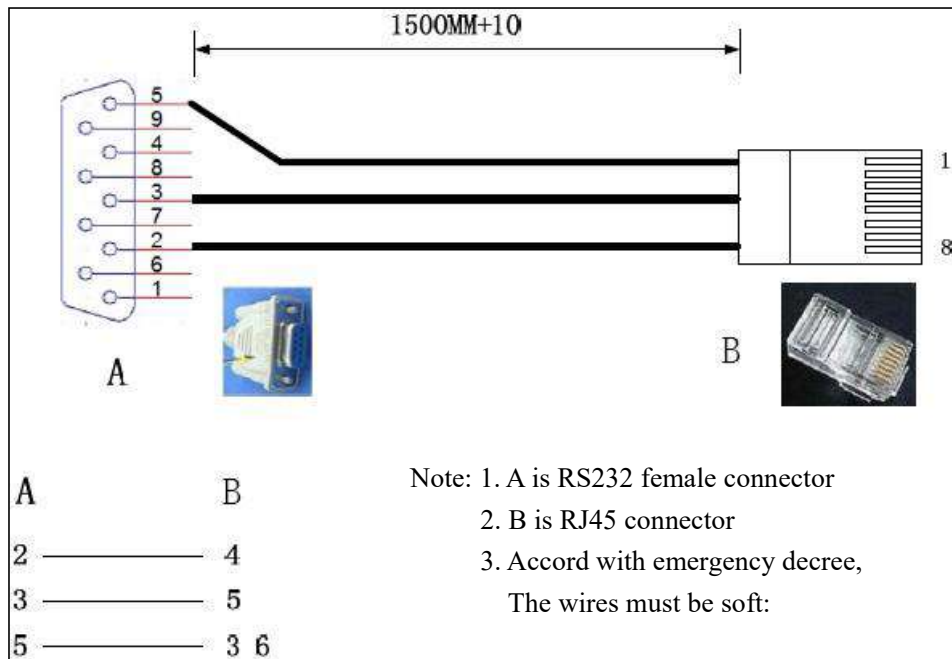

Picture 3-5b RS232 connection wires, wires order

## Chapter 4 Frontal panel button description

### 4-1 Frontal panel button sketch map

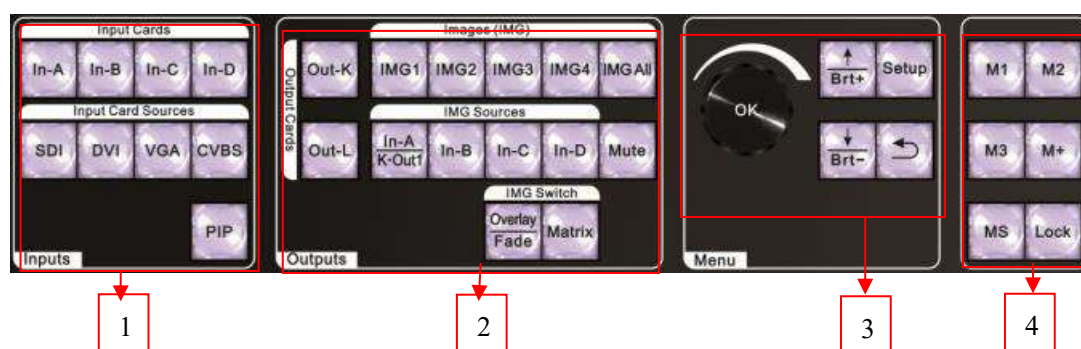

Picture 4-1 frontal panel button sketch map

- ① Input card function button
- ② Output card function button
- ③ Setup button
- ④ Display mode button

#### 1. Input card selection button

Input card selection button used to select input card.

**In-A**、**In-B**、**In-C**、**In-D**

#### 2. Input card signal source selection button

Input card signal source selection buttons, when select some signal source, the green indicator light on relative button lit up. If the input port inputted valid signal, the indicator lit up normally, or it will flicker.

**SDI**、**DVI**、**VGA**、**CVBS**

Note: press **VGA** button continually processor will adjust VGA signal automatically.

### 3. PIP on-off button

Input card PIP on-off button, after opening the green indicator light on the button flicker, waiting for select PIP signal source, under the menu "Input Card Sources" after selecting signal source, the green indicator light on the button lit up normally. The PIP signal source can be as same as the main signal or different.

**PIP**

### 4. Output card selection button

When select some output card, the red indicator light on relative button lit up, this moment you can do relative operation or setup to the output card.

**Out-K**、**Out-L**

### 5. Output image selection button

Output image selection button, when select some output image, the green indicator light on relative button lit up normally, this moment you do relative operation or setup to the output image. **IMG All** indicate select all output image.

**IMG1**、**IMG2**、**IMG3**、**IMG4**、**IMG All**

## 6. Output image signal source selection button

Output image signal source selecting button, when after selecting relative signal source for some output image, the green indicator light on the button lit up normally. Output signal source include 4 input cards, besides, through menu **H.2 In-A/K.Out1** select and configure, the output image of L card also can select the output video of Out1of K card as signal source.

**In-A/K.Out1**、**In-B**、**In-C**、**In-D**

## 7. Output image on-off button ( **Mute** )

Output image off function button, when off the red indicator light on the button lit up normally, the image is black screen status, or the indicator is closed, image display normally.



## 8. Output image overlay on-off and switch time button ( **Overlay/Fade** )

When several image furl together, every image from top layer to bottom layer has overlay order. **Overlay** is multi image overlay switch on-off button, after opening the red indicator light on the button lit up normally, or the light is closed status, after opening the function can through press output image button ( **IMG1**、**IMG2**、**IMG3**、**IMG4** ) to let relative output image display on top. The function only is valid in two application modes (2 channels dual image and 4 images).

In the work status of 2 channels dual image and 4 image application mode, press **Fade** button continually can switch and adjust Fade in/ Fade out time.



## 9. Output card matrix function on-off button ( **Matrix** )

Output card matrix switch function on-off button, after opening the red indicator light on the button lit up normally, or the light is closed status. After opening firstly through press output image button ( **IMG1**、**IMG2**、**IMG3**、**IMG4**、

**IMG All** ) to select output image, then through press output image signal source button to select relative signal source.

## 10. Setup buttons

Setup button: set processor function parameters.

**Setup**、、、**Knob**、

**Setup** : Press to enter setup menu

、 : Press to select upper or down setup option

**Knob** : Rotate **Knob** to adjust numerical value or select parameter

**OK** : Press **Knob** / **OK** button, to save parameter



 : Used for return to last menu

## 11. Brightness adjustment buttons ( **Brt+** , **Brt-** )





Brightness adjustment buttons, when device is working and operation status, press the button can increase or decrease the output brightness.

## 12. Information display

Information display (**OK**), when device is working and operation status, press knob (**OK** button) the LCD of

processor displays current setup and information. Press  or  can check the last or next option, press  button to exit the interface.

### 13. Display mode buttons ( , , , , ):

Display mode buttons, from 1 to 16 total 16 sets, display mode 1, 2 and 3 are directly selected by press  ,  and  button, meantime the indicator light on the button lit up normally; Display mode 4 to 16 selected through menu, press  button to enter display mode call menu, then rotate knob to select specific mode in menu, meantime the indicator on  button lit up.

 is display mode copy button, can copy the parameters in some display mode to another display mode.

Every set of display mode in the device includes 4 status of display image and relative parameter:



A: the size and location of output image ( include the size and location of input image, and the size and location of output image)

B: the overlay sequence of output image

C: the on-off status of output image (Mute status)

D: matrix configuration of output card

#### 14. Lock button

Lock button (  ), buttons lock function button, when lock is open the red indicator light on the button lit up, except , another buttons are not available, press  button three times continually to unlock, the red indicator light on the button is closed.

## Chapter 5 Application mode and function introduction

LVP7000 can maximum assemble 4 video input cards (every video input card include SDI, DVI, VGA and CVBS signal) and 2 output cards.

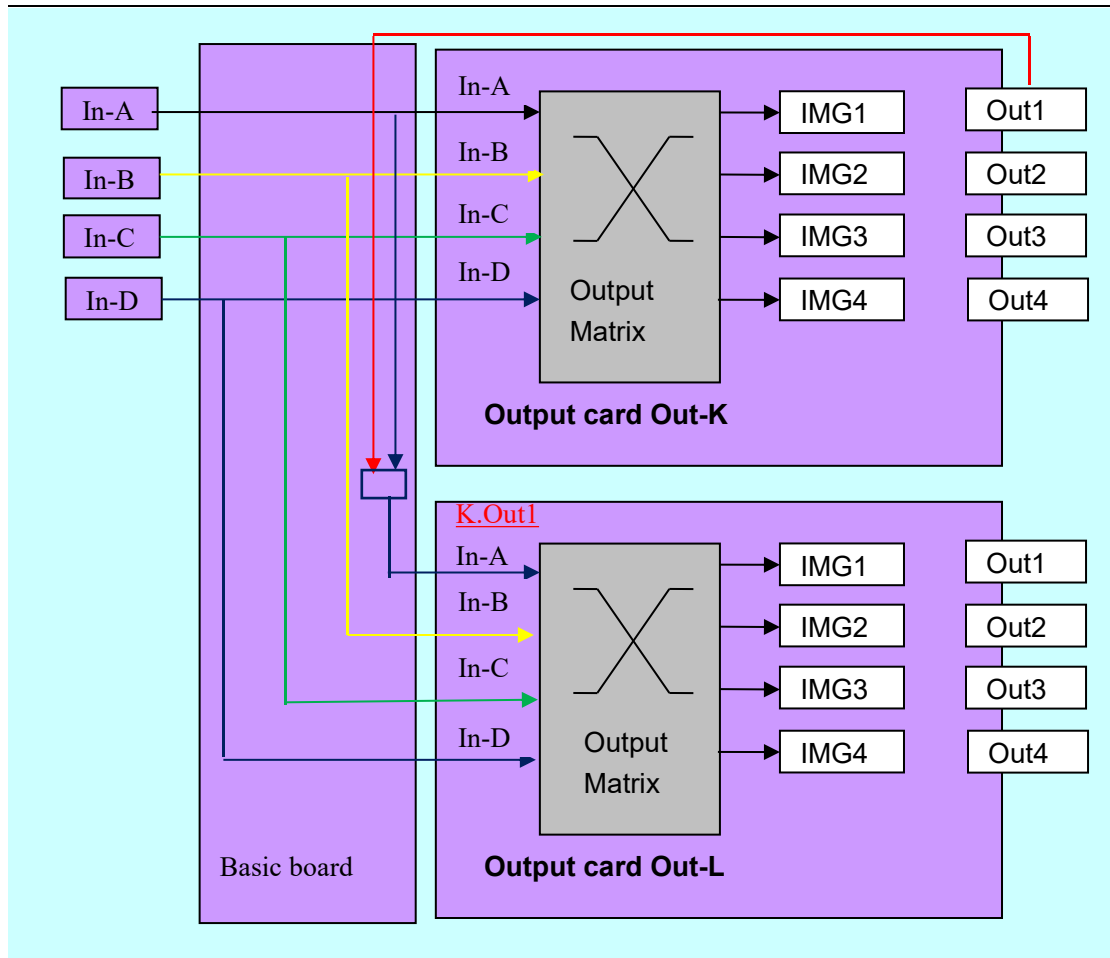

Picture 5 LVP7000 input and output diagram

As the picture shows, IMG1、IMG 2、IMG 3 and IMG 4 mean the inner output image of output card, in LVP7000 PC control software, button panel and panel LCD display, marked IMG1、IMG 2、IMG 3 and IMG 4;

In-A、In-B、In-C、In-D are the output image of 4 input card, they are through basic board connect to 2 output cards separately. K.Out1 is the Out1 port loop of K output card, through setup to replace In-A input to L output card;

Out1、Out2、Out3、Out4 mean 4 DVI output ports of output

card;

According to different application, LVP7000 output card setup has 4 kinds of different application mode (AppM), AppM1 (4 channels splicing 4:4 matrix), AppM2 (4:2 seamless switching), AppM7 (2 channels dual image), AppM6 (4 images), according to customer' s project requirement to select relative application mode.

### 5-1 AppM1 (4 channels splicing or 4:4 matrix)

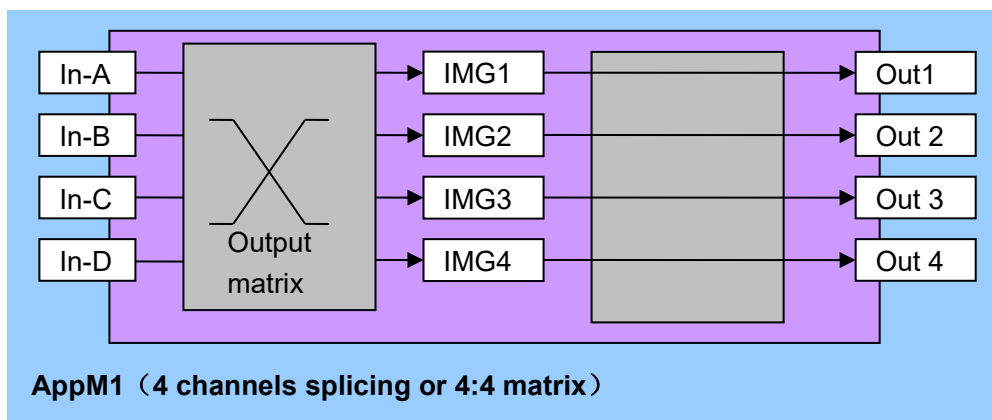

Picture 5-1A LVP7000 output card application mode1 sketch map

Under the application mode

**Out1=IMG1, Out2=IMG2, Out3=IMG3, Out4=IMG4 ,**

mean :

Output port1 (Out1) outputs image1 (IMG1)' s image

Output port2 (Out2) outputs image2 (IMG2)' s image

Output port3 (Out3) outputs image3 (IMG3)' s image

Output port4 (Out4) outputs image4 (IMG4)' s image

Under the application mode, press **Matrix** button to open matrix switch mode, then every one of output image ( IMG1、 IMG2、 IMG3、 IMG4 ) can select anyone of input card signal ( In-A、 In-B、 In-C、 In-D ) .

Especially, when IMG1、 IMG 2、 IMG 3 and IMG 4 all of them select same input card signal source, every image can separately divide and magnify input image, thereby achieve 4 output images splicing application.

The application mode is mainly applied to 4 inputs and 4 outputs seamless matrix switching or 4 outputs magnified splicing.

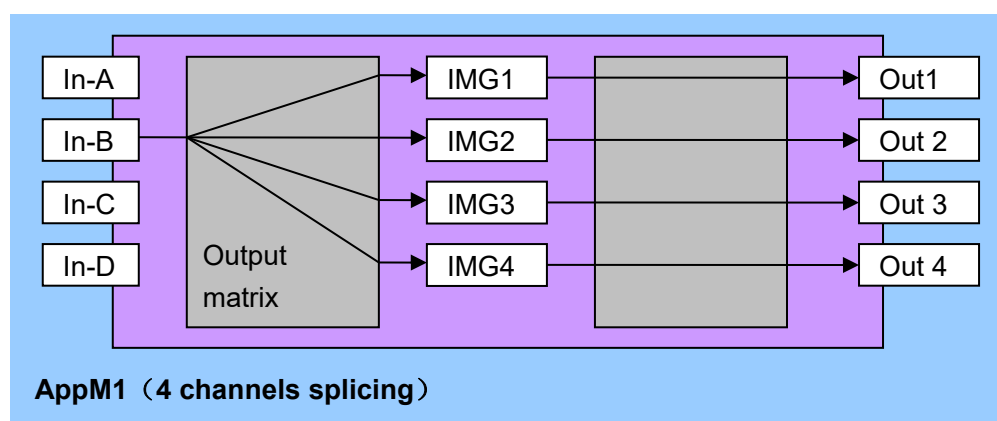

Picture 5-1b output card application mode1 4 channels splicing sketch map

## 5-2 AppM2(4:2 seamless switching)

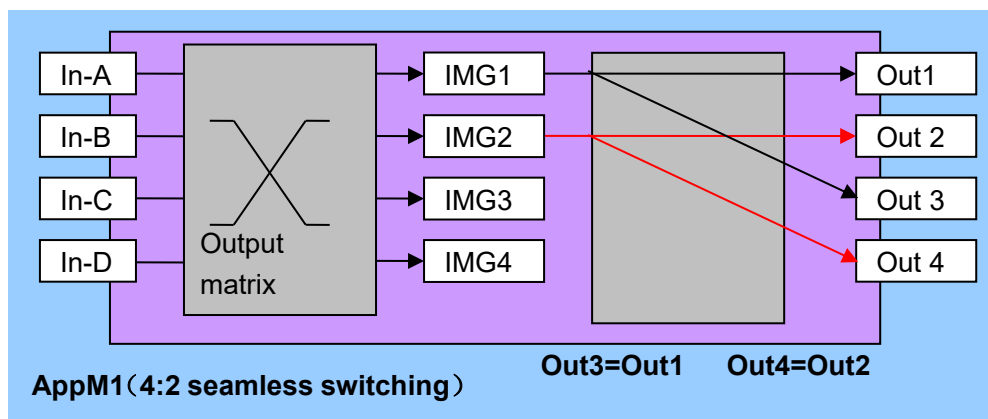

Picture 5-2a LVP7000 application mode2 sketch map

Under the application mode

**Out1=IMG1 , Out3=Out1,**

**Out2=IMG2 , Out4=Out2 ,** mean :

Out1 and Out2 separately display 2 images, the display content of Out3 and Out4 separately is as same as Out1 and Out2.

The mode is mainly used as switcher of 2 output ports, main function and feature include:

1. IMG1、IMG2 can separately select the output image of anyone of input card ( In-A、 In-B、 In-C、 In-D ) .
2. To any input signal source selected, use the switch method of seamless and fade in fade out output ( fade in fade out switch method is only valid for



Out1 and Out2 port)

### 5-3 AppM7(2 channels dual images)

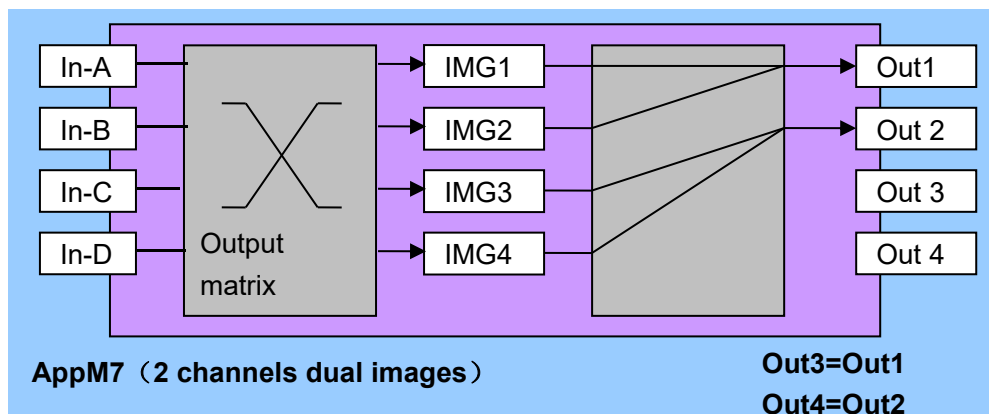

Picture 5-3a LVP7000 application mode3 sketch map

Under the application mode

**Out1=IMG1+IMG2, Out2=IMG3+IMG4,**

**Out3= Out1, Out4=Out2 , mean :**

Out1 outputs IMG1, IMG2 total two layers overlay compound image;

Out2 outputs IMG3, IMG4 total two layers overlay compound image;

The display content of Out3 and Out4 is separately as same as Out1 and Out2.

Under the application mode, press **Matrix** button to open matrix switch mode, then every one of output image ( IMG1、 IMG2、 IMG3、 IMG4 ) can select anyone of input

card signal ( In-A、 In-B、 In-C、 In-D ) .

Out1 and Out2 separately output the image of 2 output images overlay compound image. Press **Overlap** button to open layer overlay mode, press output image button directly to let relative output image display on top layer.

Under the application mode, through press **Fade** button to set the fade in fade out switch time of output image, then achieve seamless and fade in fade out switching effect.

The application mode is mainly used as dual image output processor, fade in fade out 4 x 2 matrix, dual outputs switcher, pixel to pixel HD basic picture + cross screen PIP etc.

**Note: Out3 and Out4 do not have seamless and fade in fade out switching effect.**

## 5-4 AppM6(4 images)

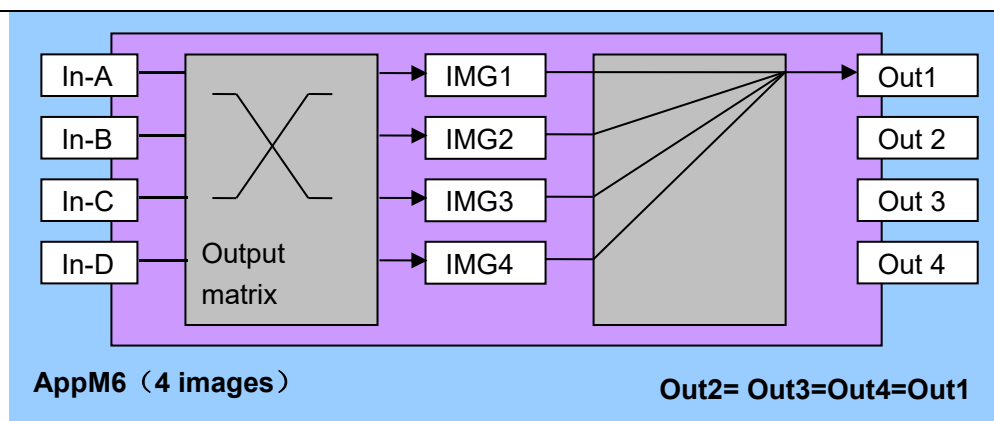

Picture 5-5a LVP7000 application mode6 sketch map

Under the application mode ,

$$\text{Out1} = \text{IMG1} + \text{IMG 2} + \text{IMG 3} + \text{IMG 4} ,$$

$$\text{Out4} = \text{Out3} = \text{Out2} = \text{Out1} , \quad \text{mean :}$$

Out1 outputs **IMG1**、 **IMG 2**、 **IMG 3** and **IMG 4** , total 4 images overlay compound image, Out2、 Out3、 Out4 output as same content as Out1.

Under the application mode, press **Matrix** button to open matrix switch mode, then every one of output image ( **IMG1**、 **IMG2**、 **IMG3**、 **IMG4** ) can select anyone of input card signal ( **In-A**、 **In-B**、 **In-C**、 **In-D** ) .

Press **Overlap** button to open layer overlay mode, press relative output image button to let the output image display on top layer.

Through press **Fade** button to set the fade in fade out switch time of output image, then achieve seamless and

fade in fade out switching effect. ( fade in fade out switch effect is only valid for Out1 port )

Otherwise, when output card work under the application mode, can call display mode M16 directly to achieve 4 images preview function.

The application mode is mainly used as 4 images processor or single output fade in fade out switcher.

## **Chapter 6 User basic operation instruction**

After system power on, LVP7000 will detect the quantity, location and configuration information of input card and output card automatically, different configuration, the display interface on LCD is different, the relative instruction below is under full configuration (4 input cards, 2 output cards) and system start under default menu.

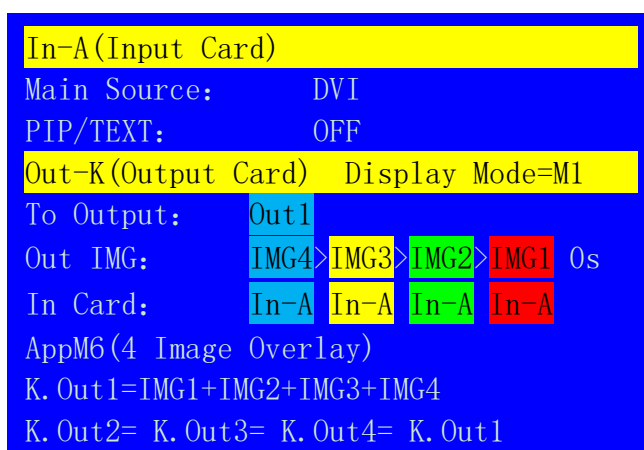
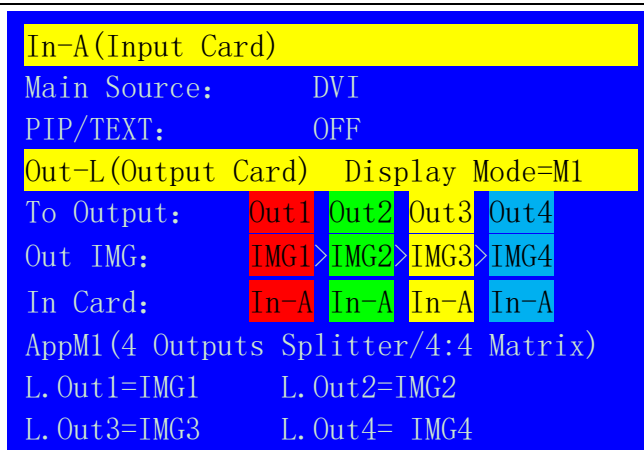

Picture 6-0 LCD interface : system default operation interface

## 6-1 Input card operation

Under user operation interface, input card operation content includes input card input signal selection, PIP operation and text overlay operation.

### 1. Input card input signal selection

Press input card button ( **In-A**、**In-B**、**In-C**、**In-D** )

to select the input card you want to operate, then press

input card signal source button ( **SDI**、**DVI**、**VGA**、**CVBS** )  
to switch signal source.

## 2. Input card PIP operation

Press input card button ( **In-A**、**In-B**、**In-C**、**In-D** ) ,  
then press **PIP** button to enter PIP ready state, then press  
input card signal source button ( **SDI**、**DVI**、**VGA**、**CVBS** )  
to select PIP signal source.

## 3. Input card text overlay operation

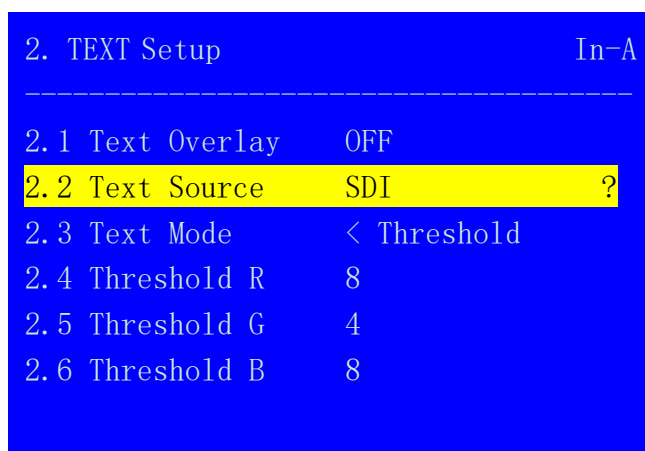

Picture 6-1a LCD interface : text setup

The relative setup of input card text overlay function  
need to enter setup menu **2. Text Setup** to configure,  
details please refer user manual [page 37](#).

## 4. VGA input signal automatic adjustment

When the input source of current input card is valid VGA input, press **VGA** button to enter VGA automatic adjustment confirmation menu, press **VGA** button again to adjust VGA signal, press  to exit menu.

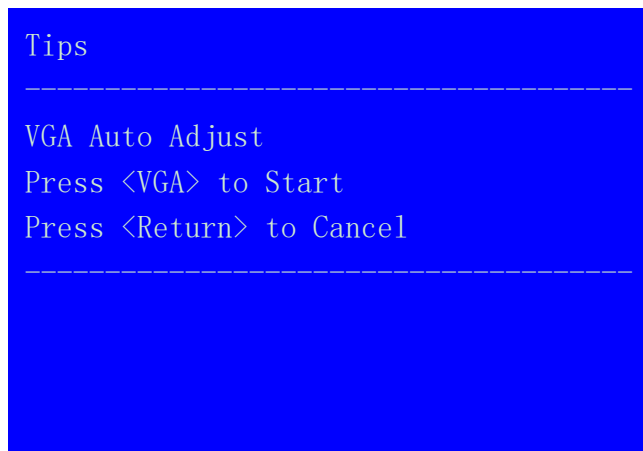

Picture 6-1b LCD interface : VGA automatic adjustment menu

## 6-2 Output card operation

Under user operation interface, the operation content of output card include: **set the relative relationship of output image and input card signal, output image overlay mode operation, switch time of output image overlay mode, display mode setup, application mode setup and brightness setup.**

### 1. Output card matrix switch

Press **Matrix** button the indicator light on the button lit up, meantime the indicator light on **Overlap** button is closed, it indicates processor has entered output card



matrix switch mode, firstly press **Out-K** or **Out-L** button to select a output card, then press image buttons ( **IMG1**、**IMG 2**、**IMG 3**、**IMG 4**、**IMG All** ) to select output image, then press image signal source button ( **In-A**、**In-B**、**In-C**、**In-D** ) to select the input channel you need.

Note:

1. Under switcher mode, also can press **Overlay** button to set the switch transient time of image signal.
2. **IMG All** indicate selecting all output image, convenient to let 4 output image select same input signal for splicing operation.

## 2. Output card output image overlay mode operation

Press **Overlap** button the indicator light on the button lit up, the indicator light on **Matrix** is closed, it indicates processor has entered overlay mode setup status, firstly press **Out-K** or **Out-L** button to select a

output card, then press image button ( **IMG1**、**IMG 2**、**IMG 3**、**IMG 4** ) can change the overlay relationship of output image, the image be selected become on top layer.

Note: the function is only valid in 2 channels dual image, multi-image application mode.

### 3. Output card image overlay switch time

When the indicator light on **Overlap** button lit up, processor has entered overlay mode setup status, continually press **Fade** button can adjust the switch time of overlay sequence of every output image, fade in fade out has 5 switch time, 1s, 2s, 3s, 4s, 5s, 0s is seamless switching. The function is only valid in 2 channels dual image, multi-image application mode.

### 4. Output card display mode setup

Display mode from 1 to 16, total 16 sets, display mode 1, 2 and 3 can be directly call by press mode button **M1** , **M2** and **M3**, meantime the indicator light on the button lit up,

display mode 4 to 16 need to be called in mode call menu, press **M+** button to open mode menu, rotate knob to select mode, meantime the indicator light on the button lit up.

**MS** is display mode copy button, can copy the parameters status in one display mode to another display mode.

Every display mode of the device includes the 4 status and relative parameter of image:

A: size and location of output image (include the size and location of input image, the size and location of output image)

B: the overlay sequence of output image

C: the on-off status of output image (Mute status)

D: matrix configuration of output card

Press **M+** button to enter display mode setup menu, press **↑** button to select display call method (mean display mode is effect with output card) as single output card call or dual output card call meantime, press **↩** button to exit.

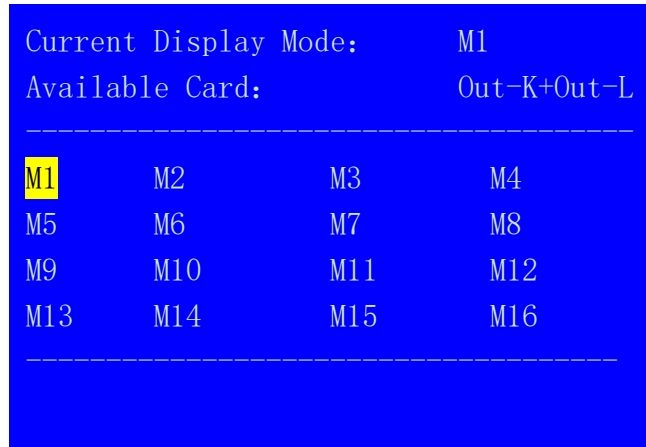

Picture 6-2a LCD interface : display mode switch

## 5. Output card application mode setup

On front panel press **Setup** button to enter "user setup" menu, press **↓** button to select "Output Card Setup" menu, press **OK** button to enter menu. Under "Output Card Setup" menu, press **↑, ↓** button to select "Advanced Setup" menu, press **↑, ↓** button to select "H.1 App. Mode" option, rotate knob adjust, press **OK** to enter "Date Will Reset" menu, press **OK** again, the new application mode is available.

## 6. Output card brightness setup

The range of brightness adjustment from 0 – 32, "0" correspond the lowest brightness, press **Brt+** button to

increase, and press **Brt** button to decrease. For ensure complete output image grayscale, normally set the output brightness value be 32, rotate knob to select single or dual card to adjust brightness.

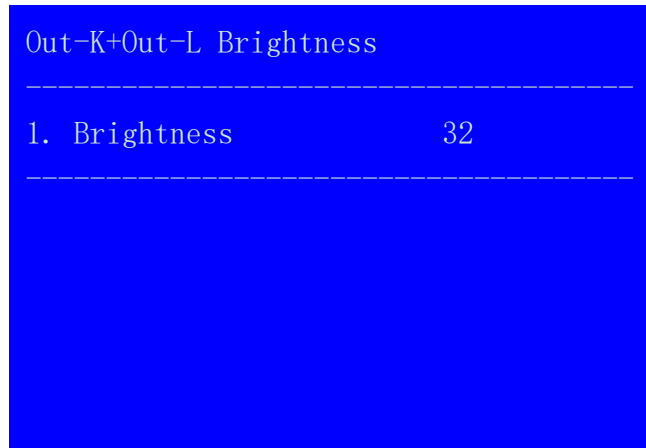

Picture 6-2b LCD interface : output brightness adjustment

## 6-3 Another function operation

Relative another operation of input card and output card, include **buttons lock, check system information** operation.

### 1. Button lock

To prevent mistake operation press **Lock** button to open lock, another buttons will be lock. When buttons

under lock status, to prevent conflict between remote operation and button operation only LAN, RS232 and USB communication are available.

When button is lock status, press **Lock** button 3 times continually to exit.

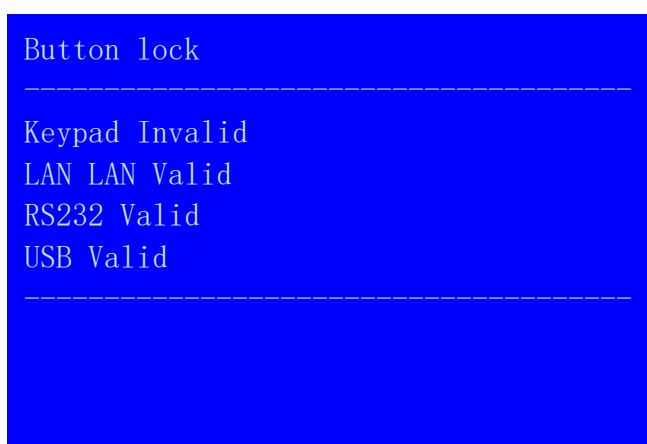

Picture 6-3a LCD interface : button lock

## 2. Check system information ( **OK** )

Press **OK** button to enter system information menu, press **↑, ↓** button to check, press **←** button to exit, system information menu as below:



Picture 6-3b LCD interface : system information

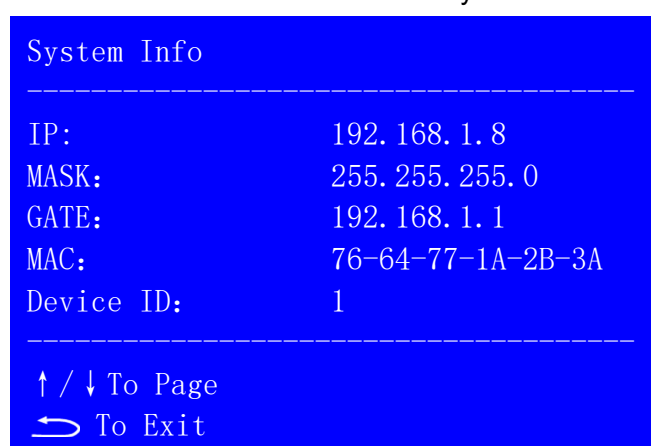

Picture 6-3c LCD interface : system information

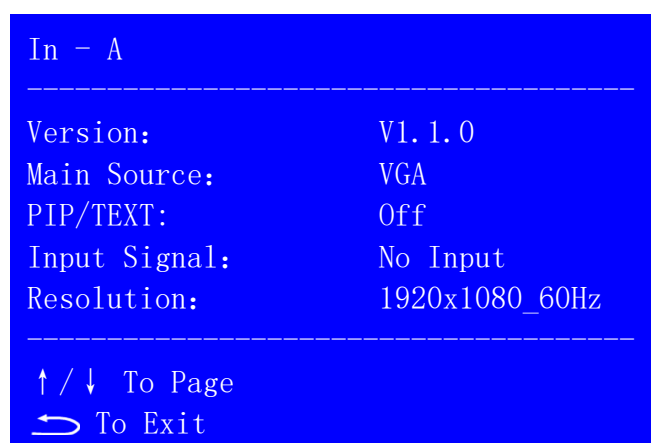

Picture 6-3d LCD interface : system information

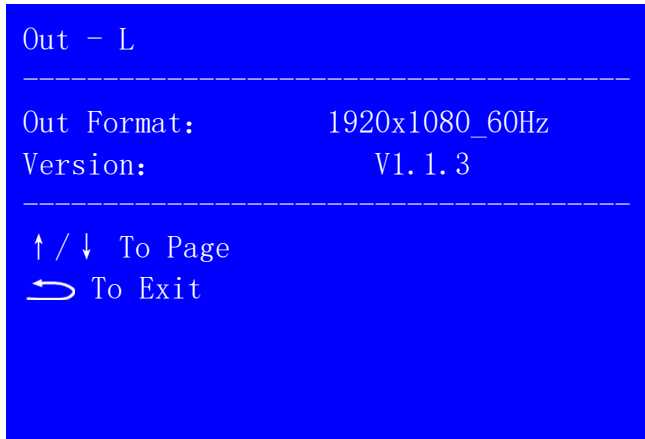

Picture 6-3e LCD interface : system information

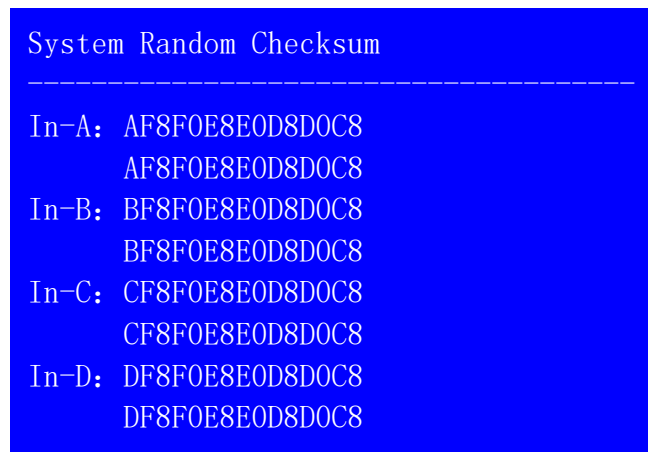

Picture 6-3f LCD interface : system information

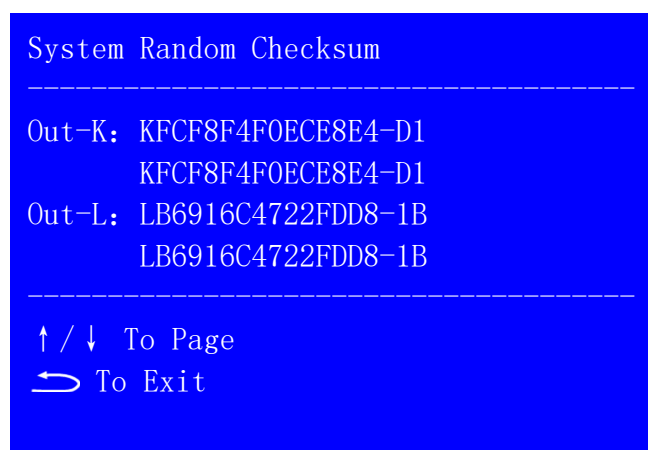

Picture 6-3g LCD interface : system information



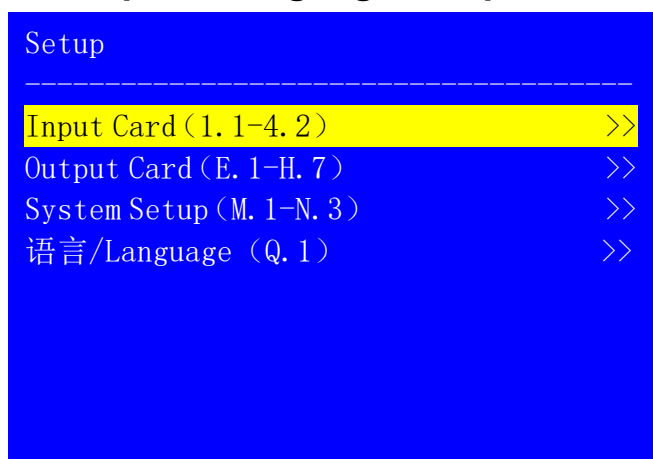

## Chapter 7 User setup menu instruction

User setup menu is about whole processor setup, total divide to be 4 modules, respectively are **input card setup**, **output card setup**, **system setup** and **language setup**.



Picture 7 LCD interface : setup

After system start, press **Setup** button to enter user setup menu, under the menu through press  button to select relative setup menu option, press knob button (OK button) to enter, press  button to return to last menu. The particular function introduction about every menu as below:

## 7-1 Input card setup

After system starting up, press **Setup** button to enter user setup menu, in the menu through press **↑,↓** button to select **Input Card Setup (1.1-4.2)**, press knob (**OK** button) to enter the setup menu as below. In the menu can configure input card parameters.

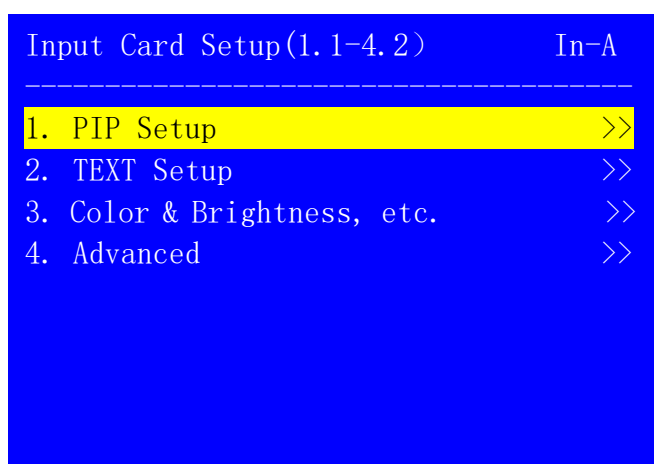

Picture 7-1a LCD interface : input card setup

### 1. PIP setup

1. **PIP setup menu** is used to set the location and size of main and PIP image. In the menu, press input card button ( **In-A** , **In-B** , **In-C** , **In-D** ) to select the input card you need to set, press **↑,↓** button to select the relative setup menu option, rotate knob (**OK** button) to

change current parameter, press knob (OK button) to save parameter.

1. PIP Setup	In-A
1.1 PIP Image Width	640 -> 645
1.2 PIP Image Height	360
1.3 PIP Image H_Start	16
1.4 PIP Image V_Start	16
1.5 Main Image Width	1920
1.6 Main Image Height	1080
1.7 Main Image H_Start	0
1.8 Main Image V_Start	0

Picture 7-1b LCD interface : PIP Setup

## 2. Text setup

2. Text setup menu is used to set the text overlay effect of input card. In the menu, press input card button ( **In-A** , **In-B** , **In-C** , **In-D** ) to select input card, then enter the menu 2.1 Text Overlay, rotate knob to change the parameter be Open, then press  button to enter 2.2 Text Source rotate knob to select relative signal source, press **OK** button to save parameter. 2.4-2.6 is used to set text threshold parameter.

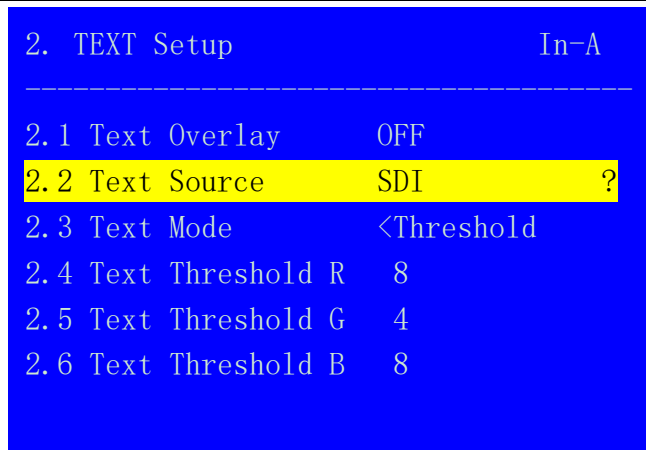

Picture 7-1c LCD interface : text setup

### 3. Image quality

3. Image quality menu is used to set the brightness, contrast and color. Press input card button( **In-A** , **In-B** , **In-C** , **In-D** ) to select input card, press **↑,↓** button to select relative setup menu option, rotate **knob** to change current parameter, press **knob** (**OK** button) to save parameter, **3.4 Reset** option is used to reset the parameter of the 3 option above.

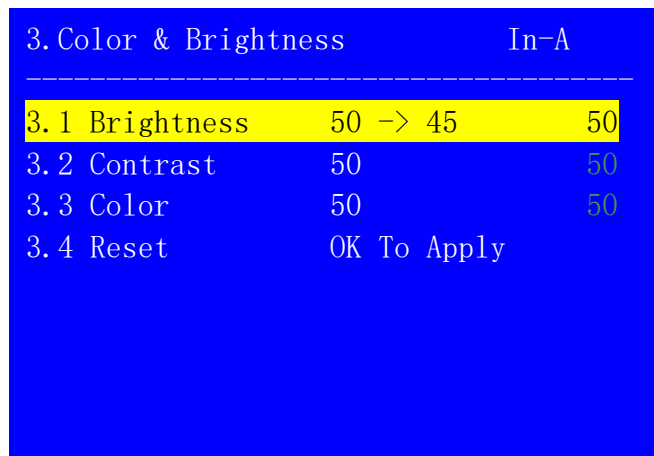

Picture 7-1d LCD interface : image quality setup

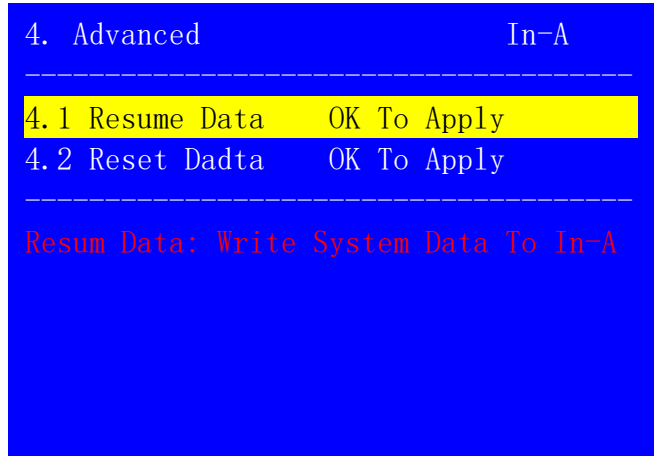

#### 4. input card advanced setup





Picture7-1e LCD interface : input card advanced setup

4. Advanced menu include 2 setup options 4.1 Resume Data and 4.2 Reset Data, the details as the table below.

Menu	Function description
4.1 Resume Data	Recover system data to input card, normally after replacing new input card we need to recover the system data
4.2 Reset Data	It is used to delete the user data in input card, to recover the data be default value, cautious to use!

Setup method: press input card button ( **In-A** , **In-B** , **In-C** , **In-D** ) to select input card, press  ,  button to select relative setup option, press **OK** button, then press **OK** button in the menu of data will reset reminder.

## 7-2 Output card setup

After system starting up, press **Setup** button to enter user setup menu, in the menu through press  ,  button to select **Output Card Setup (E 1-H.7)**, press Knob (OK button) to enter the menu as below. In the menu can set output card parameter.

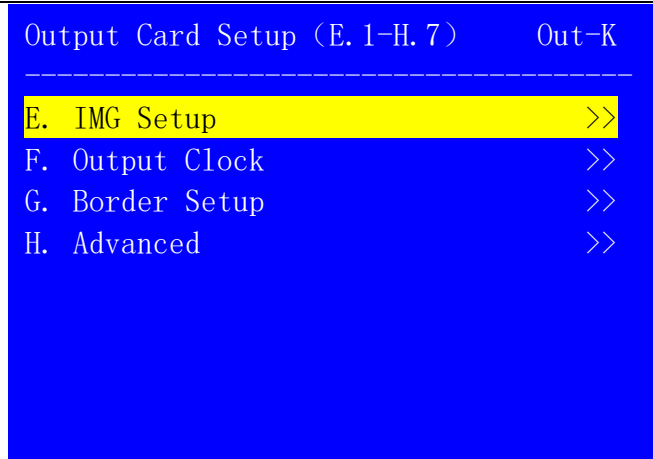

Picture 7-2a LCD interface : Output card setup

## 1. IMG setup

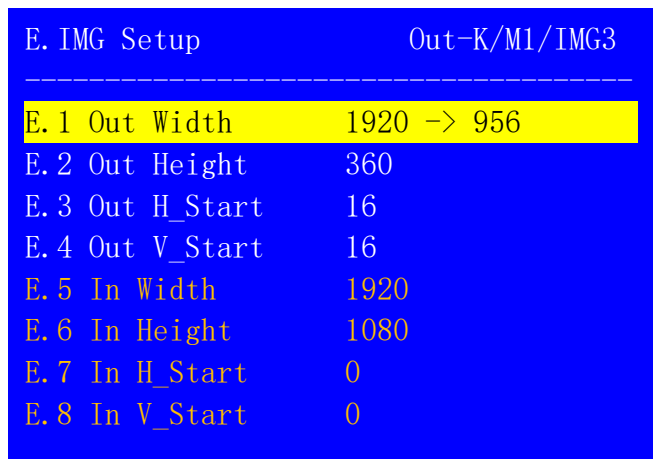

Picture 7-2b LCD interface : IMG setup

**E. IMG setup** menu is used to set the input and output parameter of output image. In the menu press display mode button( for example **M1** , **M2** )to select current display mode, press output card button ( **Out-K** , **Out-L** ) to select output card, press **↑** , **↓** button to select relative menu option, rotate **knob** to change current parameter, press **knob** (**OK**)

button) to save parameter.

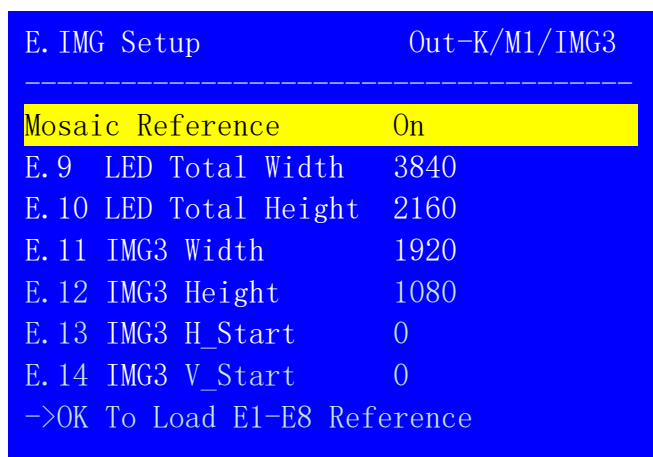

Picture 7-2c LCD interface : Splicing reference calculation

For AppM1 (4 channels splicing or 4:4 matrix), LVP7000 also can use splicing reference calculation to do fast splicing, when current menu in E.8 option press  button continually to enter the menu.

The operation method of splicing reference calculation:

1. Rotate  to open splicing reference calculation;
2. In the menu E.9-E.10 input the total width and height of whole LED screen;
3. In the menu E.11-E.14 input the size and location of LED screen the output port connect (mean relative IMG);
4. Select ->OK To Load E1-E8 Reference option



press **OK** button, then in the menu of output card IMG data will be covered, press **OK** button, the current parameter in menu E.1-E.8 update as automatic calculation parameter, meantime the right side of every relative setup option displays the parameter value of calculation;

E. IMG Setup	Out-K/M1/IMG3	
E. 1 Out Width	1920	1920
E. 2 Out Height	1080	1080
E. 3 Out H_Start	0	0
E. 4 Out V_Start 16	0	0
E. 5 In Width	960	960
E. 6 In Height	540	540
E. 7 In H_Start	0	0
E. 8 In V_Start	0	0

Picture 7-2d LCD interface : output port configuration



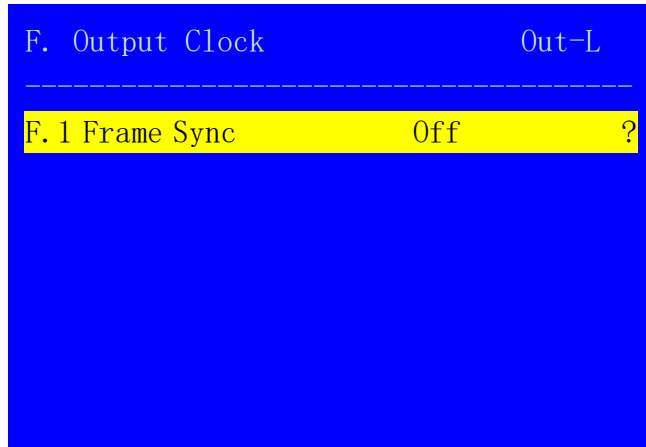

## 2. Output clock

F. output clock menu is used to set the frame synchronization status of output card. When do synchronization splicing, if have synchronous problem, please set F.1 Frame Sync be On.



Picture 7-2e LCD interface : Output port configuration

### 3. Border setup ( is only valid in AppM7 and AppM6 )

G. Border setup menu is used to set the color and border width of border of output image. Press ,  button to select relative setup menu option, rotate  to change current parameter, press  to save parameter.

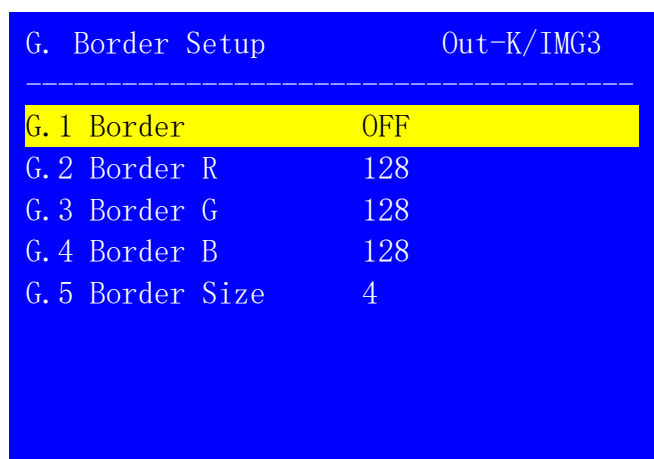

Picture 7-2f LCD interface : Border setup

## 4. Output card advanced setup

H.	Advanced	Out-K
H. 1	App. Mode	AppM6
	AppM6 (4 Image Overlay)	
	K. Out1=IMG1+IMG2+IMG3+IMG4	
	K. Out2=K. Out3=K. Out4=K. Out1	
H. 2	In-A/K. Out1 Selet	In-A
H. 3	IMG Reset	OK To Apply
H. 4	Resume Data	OK To Apply
H. 5	Reset Data	OK To Apply

Picture 7-2g LCD interface : output card advanced setup

### 1). Application mode setup

H.1 Application Mode menu is used to set application mode of output card. After selecting the menu, rotate knob to select application mode needed, meantime under the menu displays application reminder information in blue text, press **OK** button to enter Data recovery confirmation menu, then press **OK** button again, and the new application mode is applied.

**Note:** the user data of output card will be clean after configuring new application mode, careful to use!

## 2). In-A/K.Out1 selection

LVP7000 can let the output image of K.Out1 connect to L card as the signal source of matrix switch, H.2 In-A/K.Out1 selection menu is used to set input source In-A or K.Out1 when L card matrix switch. After selection the menu, rotate knob to select signal needed, press **OK** button to save setup.

Setup method: press  $\uparrow$  ,  $\downarrow$  button to select H.2 In-A/K.Out1 option, rotate knob to select In-A or K.Out1, press OK button to save.

## 3). IMG reset

When after setting some parameters, for example replace application mode or output resolution, maybe cause the input of output card instable, will appear output black screen or another abnormal display problem. H.3 IMG reset menu can let the output image recovery. But normally we don't need to do IMG reset.

Operation method: select setup option H.3 IMG, press **OK** button the output card will reset IMG.

#### 4). Data recovery and data initialization

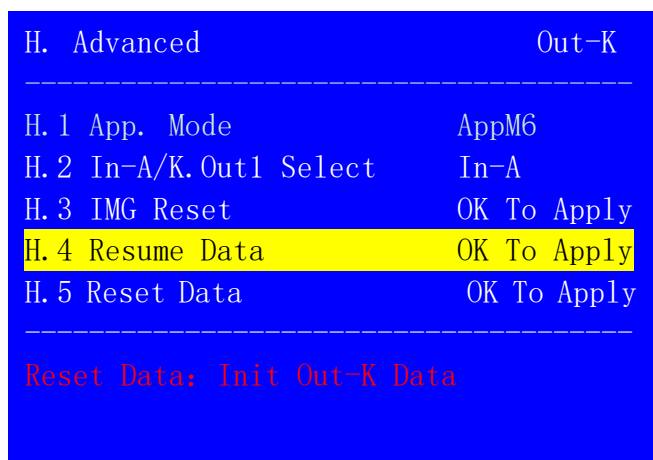

Picture 7-2h LCD interface : Output card advanced setup

The two setup options H.4 Resume Data and H.5 Reset Data, the detail function as the table below.

Menu	Function instruction
H.4 Resume Data	Recover system data to the output card, generally after replacing new output card we need to do this.
H.5 Reset Data	It is used to delete user setup of output card, recover the parameter of current output resolution and application mode be default status, careful to use!

Setup method: Press output card button ( **Out-K** ,

**Out-L** ) to select output card, press  button to select relative setup menu option, press **OK** button, then in the reminder menu of data will reset, press **OK** button again.

### 7-3 System setup

After system starting up, press **Setup** to enter user setup menu, in the menu trough press  button to select system setup (M.1-N.3), press **OK** button to enter the menu as below. In the menu can set communication parameter and output resolution and application mode of LVP7000.

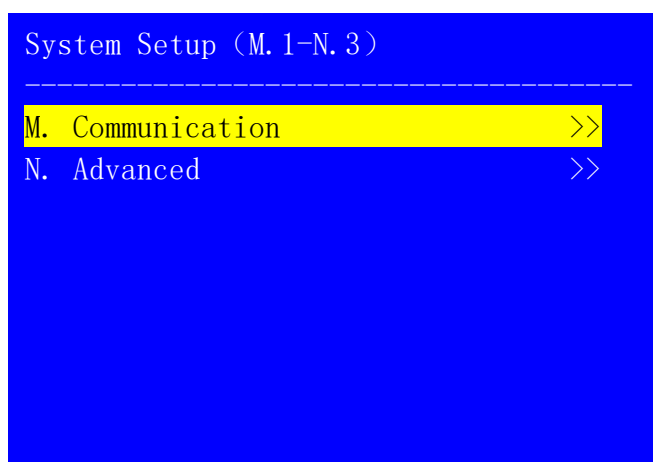



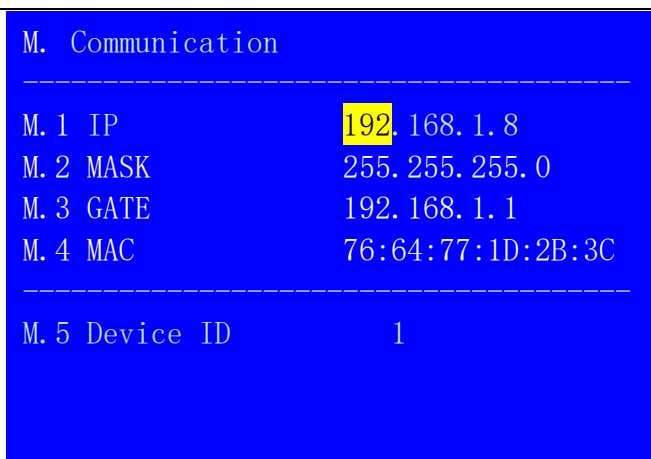

Picture 7-3a LCD interface : System setup

#### 1. Communication setup





Picture 7-3b LCD interface : Communication parameter setup

**M. communication** menu is used to set the communication parameter of network. In the menu, press  button to select adjustment setup option, rotate  to select parameter, press  button to save, when press  button to exit communication setup, the LCD screen of LVP7000 reminder " IP/MASK/GATE/MAC is Modified. Please Restart System" , according to reminder please restart LVP7000.

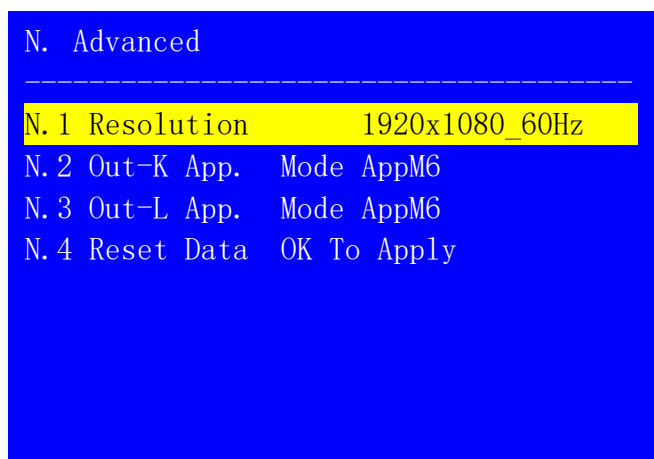
## 2. System advanced setup



Picture 7-3c LCD interface : System advanced setup

In the menu can set the output resolution of processor , and the application mode of output card, setup method: separately enter output resolution and application mode setup option, to select the parameter needed, then press  button to enter N.4 Reset Data setup option, press  button, there will be a reminder information on LCD screen "Data Will Reset!" press  button processor start to apply new output resolution and application mode setup, also can directly enter N.4 Reset Data setup option to clean the user data of LVP7000, and



to recover the current output resolution and application mode be default status.

**Note:** changing application mode will cause the user data in the output card cleaned, careful to use!

## 7-4 Language setup

After system starting up, press **Setup** to enter user setup menu, in the menu through press **↑**, **↓** button to select **语言/Language (Q.1)** press **OK** button to enter the menu as below. Press **OK** button again to enter (Q.1) **语言/Language** rotate knob to select the language needed, press **OK** button to save.

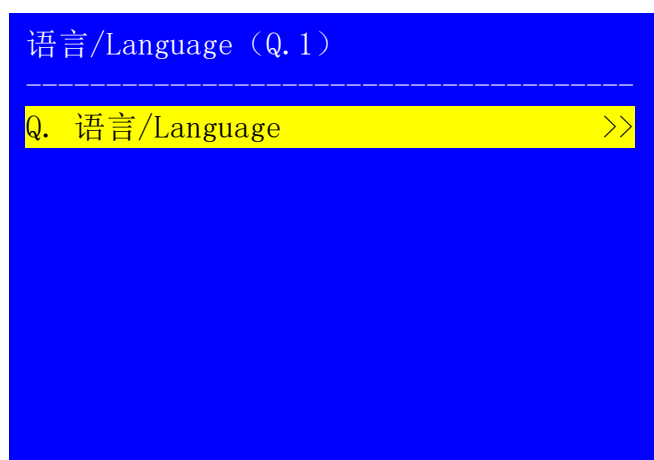

Picture 7-1a LCD interface : Output port configuration



Picture 7-1a LCD interface : Output port configuration

## Chapter 8 System maintenance and relative operation instruction

LVP7000 adopt inserting card structure design, and add system data recovery and random adjustment and verification function, PC software import and export function, very convenient for project maintenance.

As below separately explain **system random adjustment and verification**, **data recovery** and **PC software import and export function**.

### 8-1 System random adjustment and verification

There are backup data for the input and output card of LVP7000 in backboard system. When operate and set, the

two data will change meanwhile.

After changing output resolution and application mode, LVP7000 meantime will separately write a group of same random data to backboard system and relative input and output card, it is called system random checksum value. The value can through press **OK** button to enter system information menu to check.

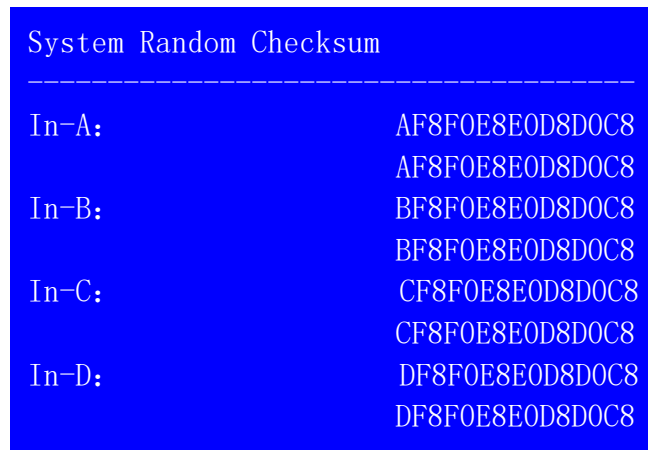

Picture 8-1a LCD interface : System random checksum value

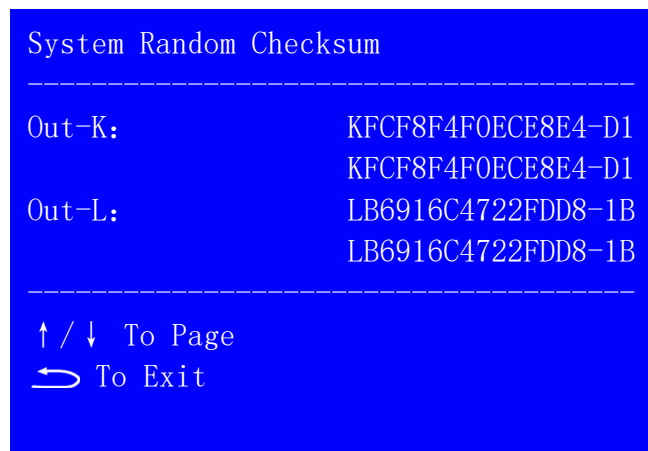

Picture 8-1b LCD interface : System random checksum value

As the picture above show about system random checksum value:

1. Every card has two checksum values, the first line is system checksum value, and the second line is the checksum of the card;
2. The first bit of checksum correspond to card, for example as K start, it indicates the data belong to K card;
3. If the card has communication abnormal or data deranged, the checksum of the card is not as same as the system' s, it is displayed by red text, meantime has starting up reminder when start up the device.

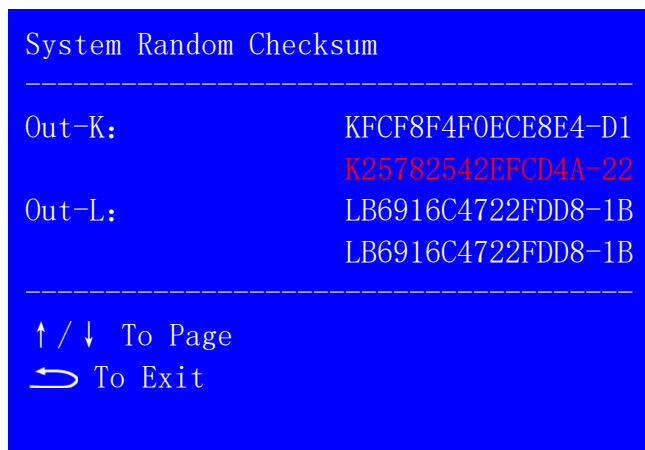

Picture 8-1c LCD interface : System random checksum value

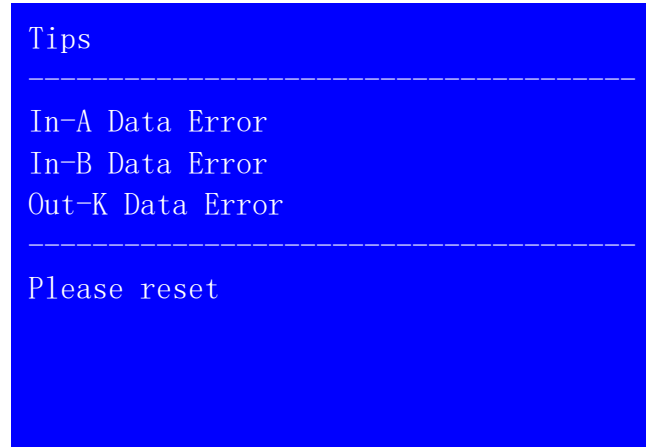

Picture 8-1c LCD interface : Starting up error reminder

## 8-2 Data recovery

After replacing new card or card has data error, we can write the original data we saved in system to relative card, to avoid set the parameters repeatedly, it is the function of data recovery. The menu is in the setup option of input card 4.1 Resume Data and output card H.4 Resume Data. (Refer user instruction page 38 and page 45)

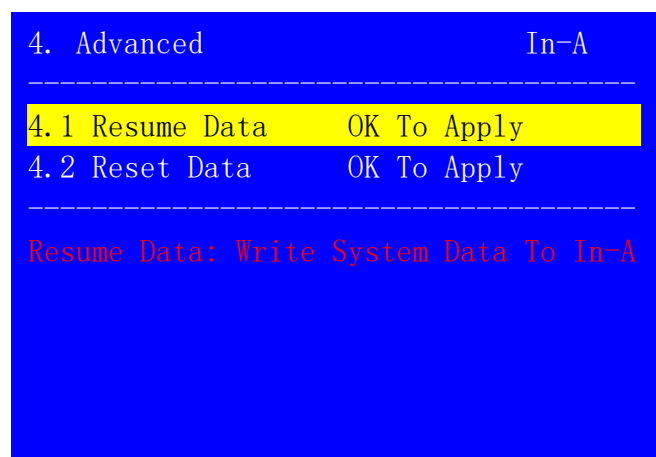

Picture 8-2a LCD interface : Input card data recovery

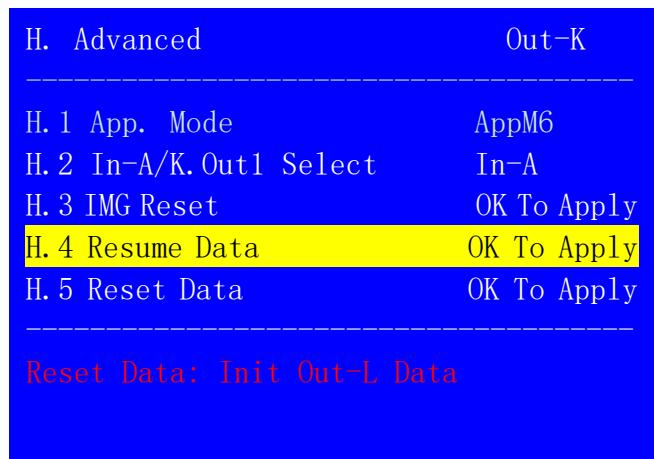

Picture 8-2b LCD interface : Output card data recovery

### 8-3 PC software import and export

Except the data recovery mentioned in front, we also can use PC software import and export function.

PC software export function we always use after device configuration ok, it can back-up all current setup parameter of input card and output card as configuration file in PC. PC software import function can import the backup configuration file saved in PC to LVP7000, let LVP7000 recover to previous good setup status.



Picture 8-3a PC software import and export

## Chapter 9 Mode instruction

LVP7000 serials adopt insert card design method, the quantity of input card and output card depend on requirement to custom-make. The specific mode description as below:

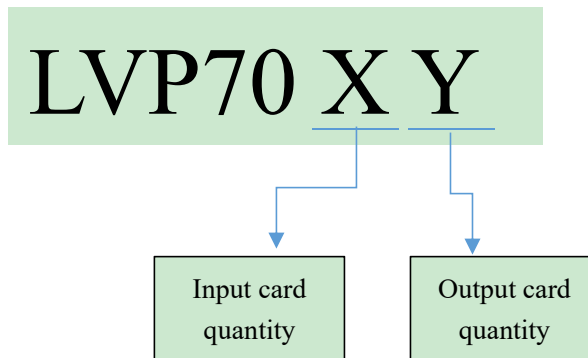

For example LVP7032 means configuring 3 input cards, 2 output cards